

CONSTRUCTION, FUNCTION AND INFLUENCE OF EXHAUST GAS RECIRCULATION UPON POLLUTANTS

Daniel LITA¹, Ion Tabacu², Florian IVAN²

¹Dacia Cars, Romania

²University of Pitesti, Romania

Abstract: The paper presents the results obtained from a depollution point of view after the NEDC cycle using the Exhaust Gas Recirculation.. There are presented the values of the main pollutants established according to EURO 4 standard, obtained in two cases: the correct functioning of the Exhaust Gas Recirculation system and the faulty functioning highlighting the European on Board Diagnostics standards.

Key words: Exhaust Gas Recirculation, European On Board Diagnostic, EURO 4.

1. INTRODUCTION

Like the gas engines, the diesel engines are subjected to very strict standards of depollution. The polluting emissions of these engines are mainly the following:

- Nitrogene oxide (NO_x)
- Carbon monoxide (CO)
- Hydrocarbons (HC)
- Solid particles.

The means used to control pollution are similar to these of the gas engines, but the control strategies are different.

1.1. Euro standards regarding pollutants

Standard evolution is highly related to technology evolution. This shows that in 15 years (Euro I – Euro IV), the NO_x emissions, the CO emissions and the particles have been reduced more than over 75%.

Table1

Diesel						
(g/km)	Euro 1	Euro 2	Euro 3	Euro 4	Euro 5	Euro 6
Date	Jul-92	Jan-96	Jan-00	5-Jan	09.Sep	sep.14
CO	2,72	1	0,64	0,5	0,5	0,5
Nox	-	-	0,5	0,25	0,18	0,08
HC+Nox	0,97	0,7	0,56	0,3	0,23	0,17
PM	0,14	0,08	0,05	0,025	0,005	0,0045

1.2 New European Driving Cycle

Before carrying out the cycle the car maceration for 12 hours at a temperature of 20⁰ C is compulsory. In order to establish the NO_x emissions the cycle has been divided into three sampling steps:

- 1) the cold ECE urban step (max 50 km/h)
- 2) the worm ECE urban step (max 50 km/h)
- 3) the extra-urban EUDC (max 120 km/h)

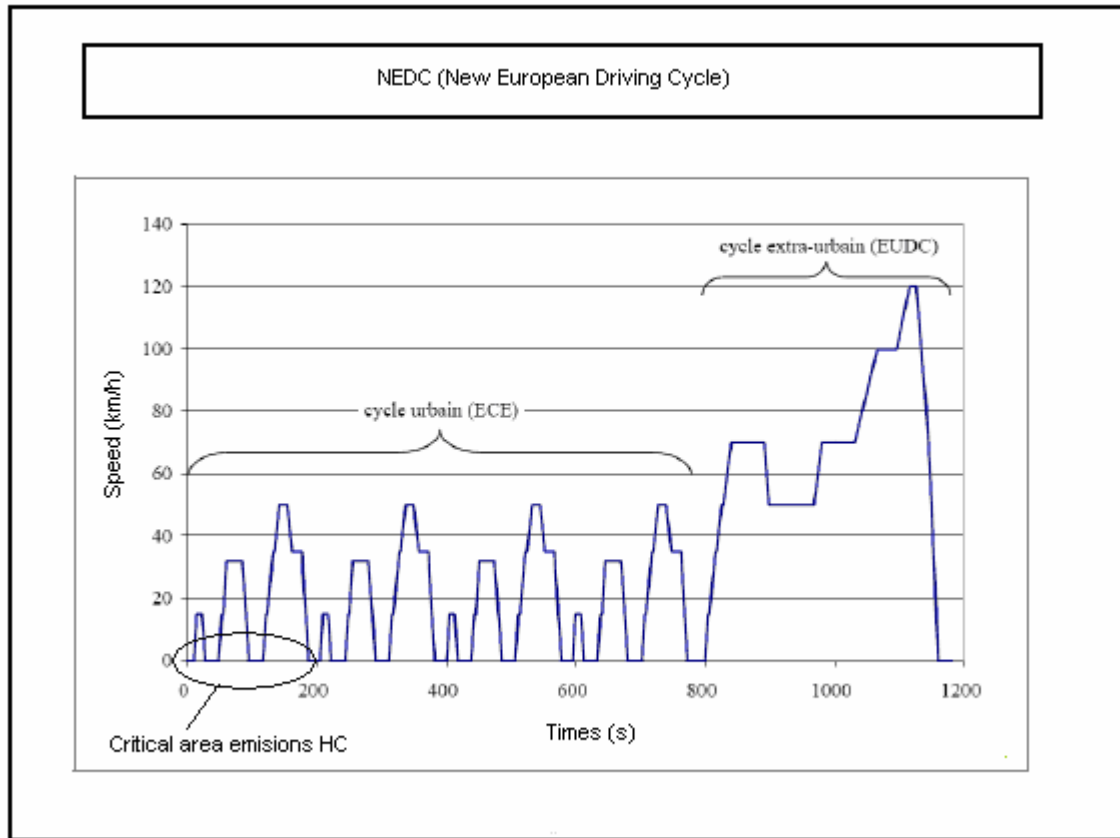

Figure 1

Speed max =120 km/h; Speed average=33,6 km/h; Time = 1180 s; Distance = 11,007 km

Table2

Acceleration or Stabilized speed(km/h)	Switch lever position for Acceleration or deceleration	Slow-ups (km/h)	Features of deceleration
0 to 15	1	15 to 0	Clutch release at 10 km/h
15 to 35	2	35 or 32 to 0	In the second gear up to 10 km/h then clutch release
35 to 50	3	50 to 35	-
50 to 70	4	70 to 50	4 seconds in 5'th gear then 4 seconds in 4'th gear
70 to 120	5	120 to 0	Clutch release at 50 km/h
100 to 120	6	120 to 0	Clutch release at 50 km/h

1.3 EOBD Standards (European on Board Diagnostics)

The EOBD standards require the computer detection of all the faulty components that could have a negative impact on the NOx emissions. These standards consist in carrying out the NEDC cycle simulating certain breakdowns in the depollution systems to highlight the impact upon pollutants. For example, in the case of the EGR system the simulation consists in blocking the shutter in different

positions to show this thing. After carrying out the different simulated cycle operating troubles one analyzes the NOx emissions to see if these have passed the EOBD standards.

Table3

Standards	HC	CO	Nox	PM
	g/km	g/km	g/km	g/km
EU IV standard	0.05	0.5	0.25	0.025
EOBD standard	0.4	3.2	1.2	0.18

When the NOx emissions pass the EOBD standards during an operating trouble, then a yellow indicator light OBD will light on the dashboard showing the breakdown.

2. THE DESCRIPTION OF THE EGR FUNCTIONING SYSTEM

This system lowers the burning point by replacing the oxygen excess with exhaust gases; the formation of nitrogen oxides is an exponential function with temperature and it depends on oxygen. In fig 1 the plan of the functioning principle of the EGR system is presented pointing out the functions presented/described above.

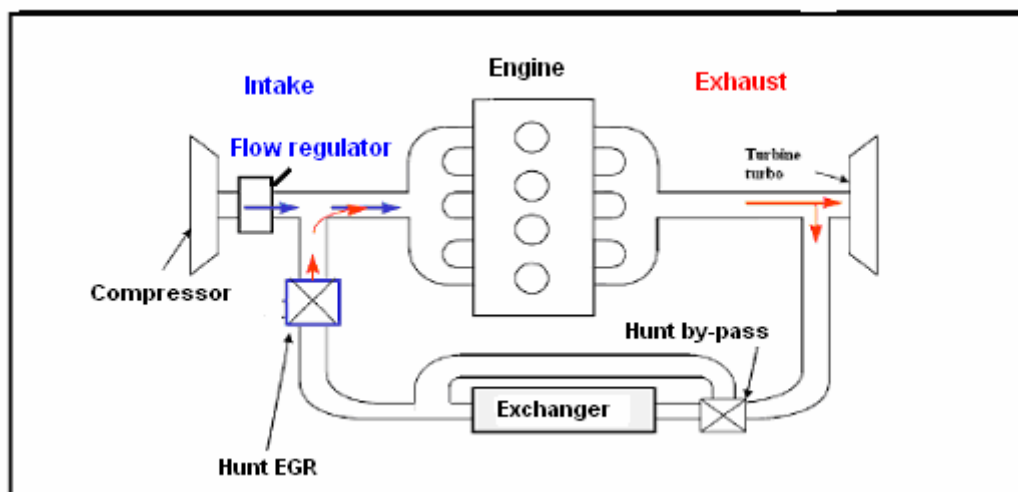

Figure2

3. EXPERIMENTAL STUDY ABOUT THE EGR SYSTEM

For the experiments one has decided to carry out the NEDC cycle with a Diesel middle-class car which has been acclimatized for 12 hours at 20⁰ C. The NEDC cycle has been carried out three times, in the case of the first cycle we notice in the diagrams the correct functioning of the EGR depollution system (field 1,1'), and in the case of the other two cycles one has simulated two breakdowns of the EGR system for the EOBD standards. The first breakdown consists in blocking the shutter in closed position (field 2,2'), and the second one points out the blocking of the shutter in open position (field 3, 3').

In table 4 one can see the values of 6 measurements made during the NEDC cycle when there are highlighted: the EGR functioning, the car speed, the time, EGR and AMF feedback. The conditions under witch the measurements were made are to be found in fig. 3-8 following the red straight line.

Table4

Condition	EGR functioning	Speed [km/h]	Time [s]	Feedback EGR [%]	AMF (air mass flow) [mg/cycle]
C 1	Closed blocked	0	46	0	423
	normal	0		10.85	284
	Open blocked	0		16	260
C 2	Closed blocked	33.8	75	0	498
	normal	33.4		9.38	301
	Open blocked	33.5		16	250
C 3	Closed blocked	20.1	517	0	463
	normal	20.7		8.2	324
	Open blocked	20.4		16	247
C 4	Closed blocked	21.2	573	0	443
	normal	20.5		19.3	284
	Open blocked	21.1		16	296
C 5	Closed blocked	104.1	1085	0	603
	normal	103.9		9.99	425
	Open blocked	104.4		16	359
C 6	Closed blocked	119.1	1111	0	743
	normal	121.4		6.8	601
	Open blocked	119.6		16	507

a) The functioning at low charges: (fig 3-4) at low charges the exhaust gases still contain a lot of oxygen and that is why one can increase the EGR percentage without having a smoke or carbon dioxide increase. At cold, the temperature of the combustion chamber's walls being low fasters the HC and CO, with the help of EGR system the intake temperature increases leading to the diminishing is insignificant. This temperature increase is also favorable to the silencing of the catalytic exhaust box. If the EGR percent is very big then the burning lowering hinders the useful effort in spite of the lead corrections to the injection.

b)The functioning within speed-ups and slow-ups: (fig 5-6) in the case of the speed-up EGR system a small amount of gases recirculates so that the burning cannot be affected leading to the decrease of performances. In the case of slow-ups the recirculation rate increases helping to maintain in a silencing state the catalytic exhaust box.

c) The functioning at high charges: (fig. 7-8) on the contrary at high charges the oxygen being enough for the burning, the introduction of a big quantity of EGR would affect the burning and the useful effort, but it would foster the appearance of CO and HC.

It is important in certain points of the functioning to have a significant percent of EGR which leads to a major decrease of NOx.

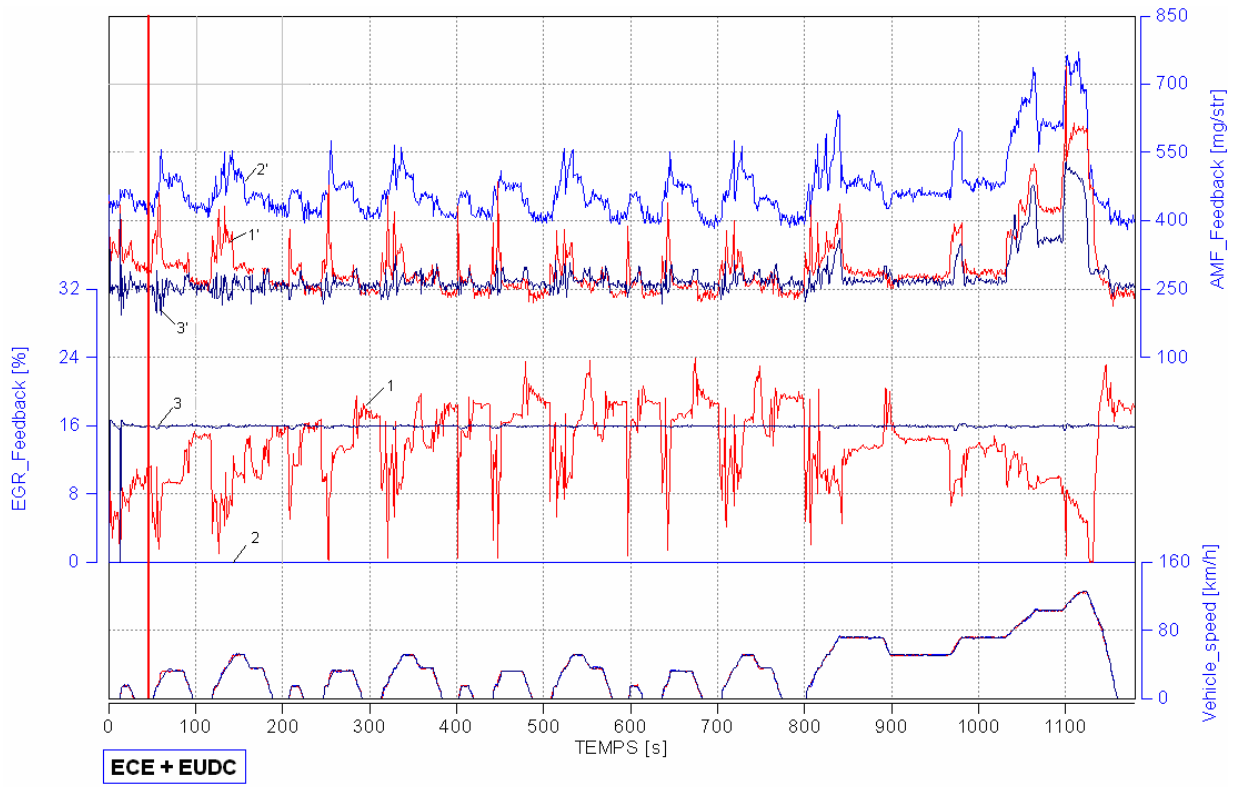

Figure3

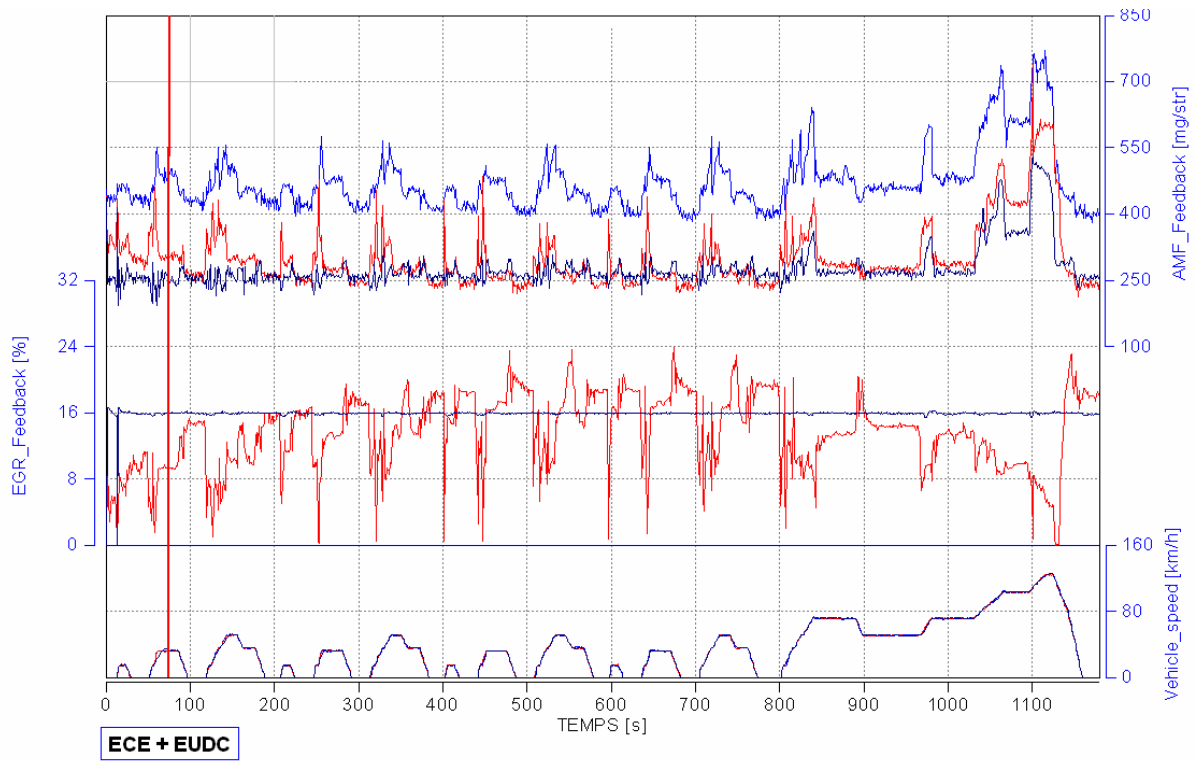

Figure4

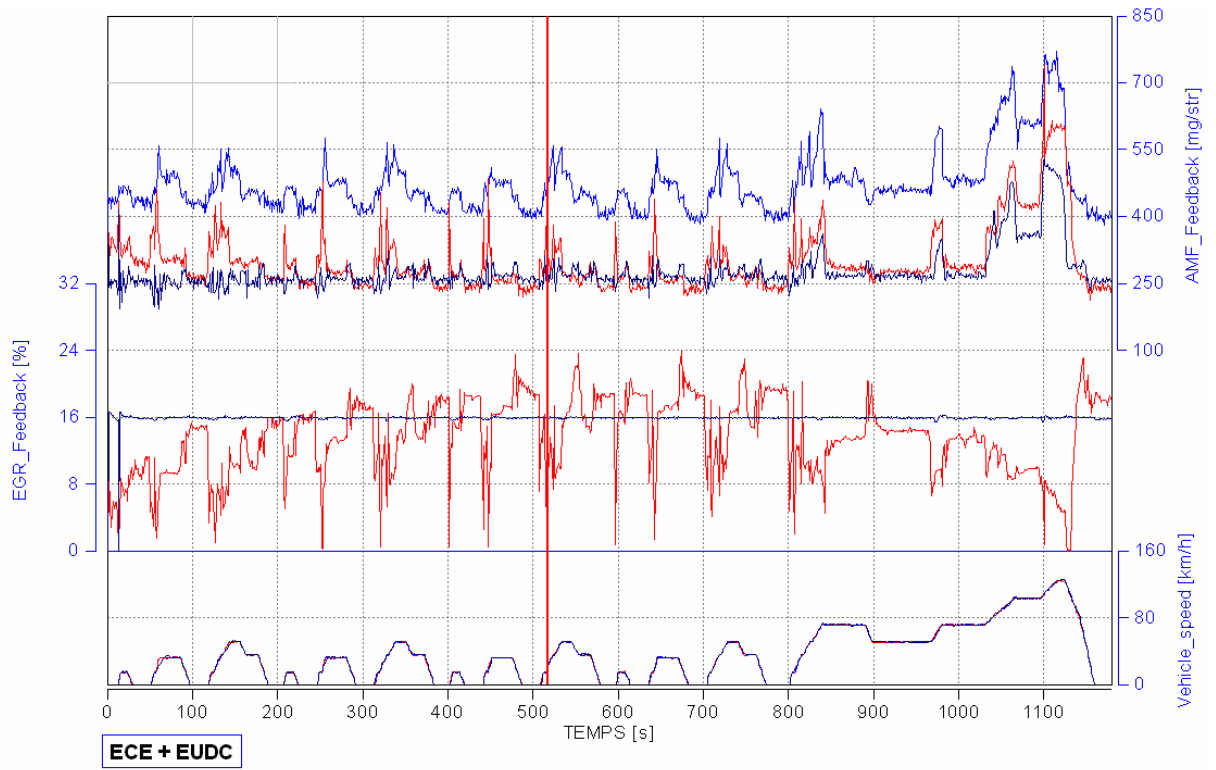

Figure5

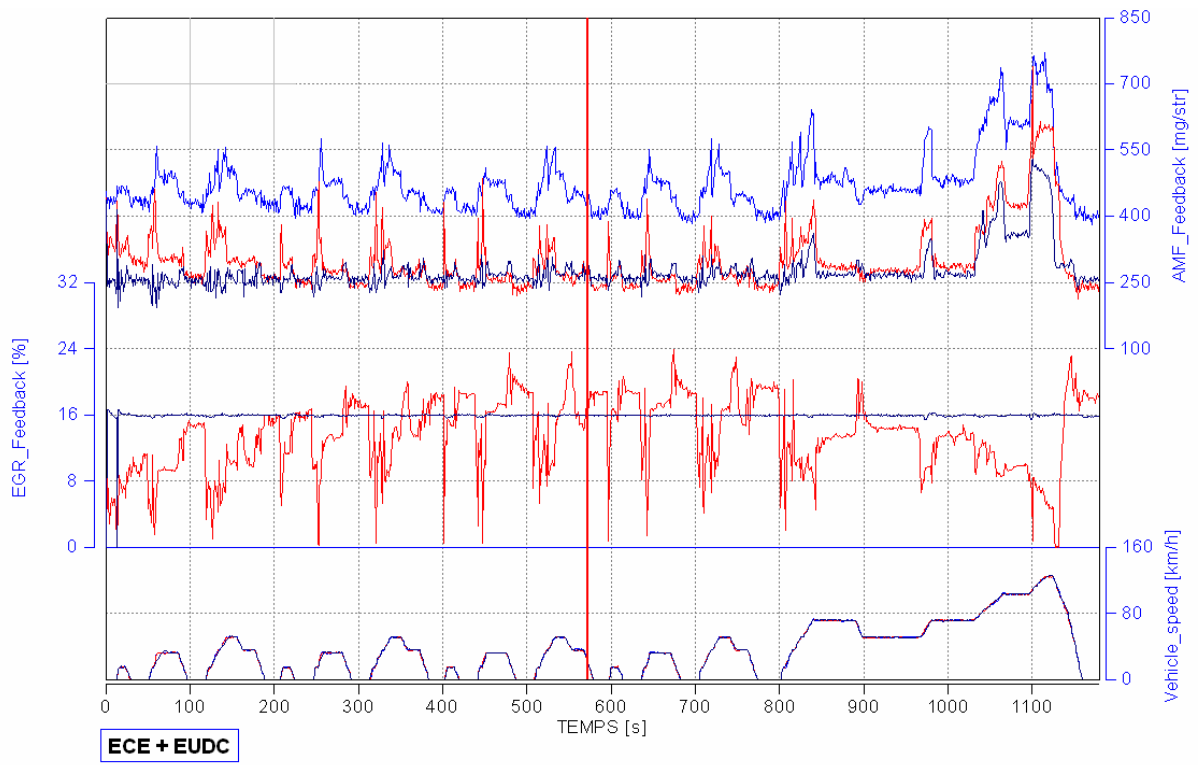

Figure6

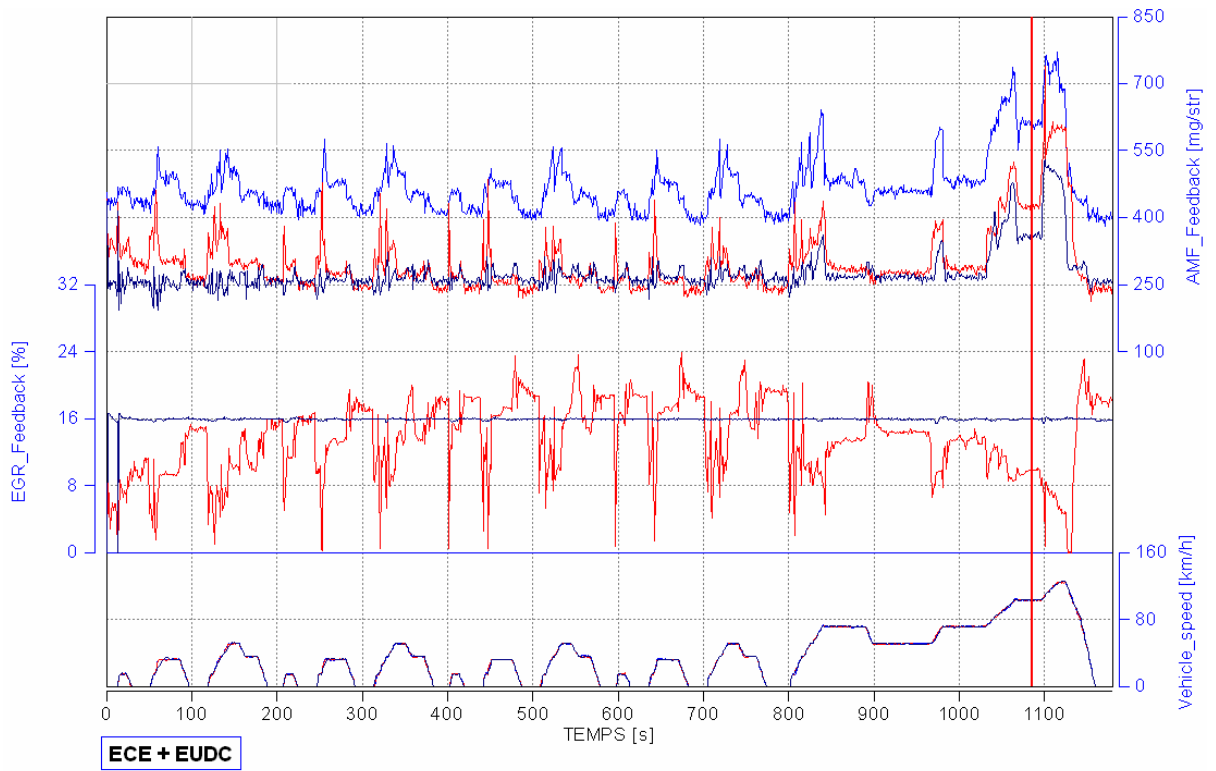

Figure7

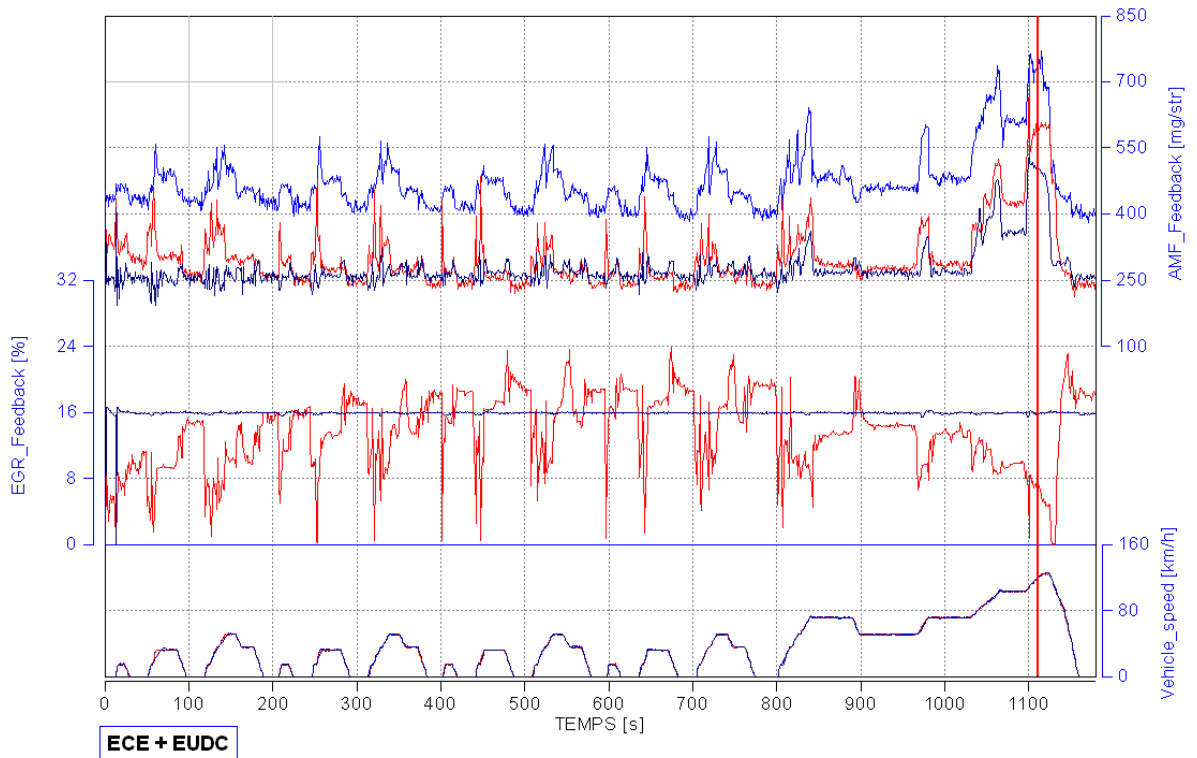

Figure8

In table 5 one can see the main values of the NO_x obtained during the NEDC cycle for the two functioning cases of the EGR.

Table5

Standards	HC	CO	Nox	Part	
	g/km	g/km	g/km	g/km	
EURO IV standard	0.05	0.5	0.25	0.025	
EOBD standard	0.4	3.2	1.2	0.18	
OBD tests	0.046	0.747	0.751	0.014	Closed blocked
	0.26	1.791	0.121	0.161	Open blocked 40%
EURO IV test	0.019	0.052	0.221	0.022	

4. CONCLUSIONS

This experimental study on the EGR system highlights its positive influence upon pollutants and especially upon NO_x, a NO_x emission which is hard to fight against and also very dangerous to the human body.

5. REFERENCES

- [1] *** ENSPM, *Course notes*, 2009
- [2] Plint, J., Martyr, T., *Engine testing , Theory & Practice*, SAE, Casebound,2007
- [3] Khair, M., Majewski, A., *Diesel emissions and their control*, SAE, Hardbound,2006