



ELECTROMECHANICAL DRIVE SYSTEM WITH SEPARATELY EXCITED DIRECT CURRENT MOTOR

Ion ION-GUTA*
University of Pitesti, Romania

Article history:
Received: 15.11.2015; Accepted: 18.03.2016.

Abstract: This paper presents a simulation of the speed control of a separately excited direct current motor using LMS Imagine Lab/AMESim environment. Purpose of a motor speed controller is to take a signal representing the required speed and to drive a motor at that speed. In the independent excitation DC motor, field voltage was varied in order to study how it affected motor speed and current. Both the resistive torque and armature voltage were kept constant. A speed regulation loop is added that imposes a torque command. This torque command will in turn control both armature and field currents. Finally shows the main characteristics in steady state operation of this type of motor.

Keywords: direct current motor, simulation, speed control, AMESim.

INTRODUCTION

DC motor drives are used for many speed and position control systems where their excellent performance, ease of control and high efficiency are desirable characteristics. DC motors are in general much more adaptable to adjustable speed drives than ac motors which are associated with a constant speed rotating fields. Indeed this susceptibility of dc motors to adjustment of their operating speed over wide ranges and by a variety of methods is one of the important reasons for strong competitive position of dc motors in modern industrial drives. DC motors can be classified according to the electrical connections of the armature winding and the field windings. The different ways in which these windings are connected lead to machines operating with different characteristics. The field winding can be either self-excited or separately-excited, that is, the terminals of the winding can be connected across the input voltage terminals or fed from a separate voltage source. Further, in self-excited motors, the field winding can be connected either in series or in parallel with the armature winding. The field windings are used to excite the field flux. Armature current is supplied to the rotor via brush and commutator for the mechanical work. Interaction of field flux and armature current in the rotor produces torque. These different types of connections give rise to very different types of motors. As shown in Figure 1, a cross-sectional view of a DC motor with separate excitation (SEDC) is presented.

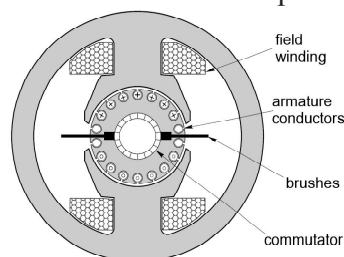

Figure 1. Cross sectional view of SEDC motor [1]

* Corresponding author. Email: ion.ion@upit.ro

Equivalent circuit of separately excited DS motor is shown in figure 2. When a separately excited motor is excited by a field current of i_f and an armature winding current of i_a flows in the circuit, the motor develops a back emf and a torque to balance the load torque at a particular speed [2], [3]. The i_f is independent of the i_a . Each windings are supplied separately. Any change in the armature current has no effect on the field current.

The i_f is normally much less than the i_a .

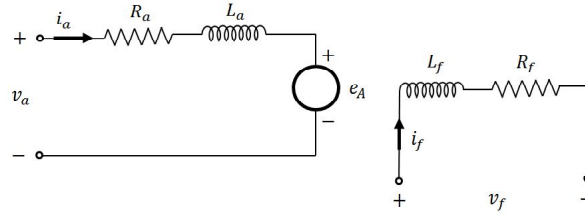

Figure 2. Equivalent circuit of SEDC motor

FIELD AND ARMATURE EQUATIONS

Instantaneous field voltage:

$$v_f = R_f i_f + L_f \frac{di_f}{dt} \quad (1)$$

Where R_f and L_f are the field resistance and self-inductance of the field windings, respectively.

Instantaneous armature voltage:

$$v_a = R_a i_a + L_a \frac{di_a}{dt} + e_a \quad (2)$$

Where R_a and L_a are the armature resistance and self-inductance of the armature windings, respectively.

The motor back emf, which is also known as speed voltage (the generated voltage corresponding to the field current i_f at the motor speed ω), is expressed as:

$$e_a = L_{af} i_f \omega \quad (3)$$

where L_{af} is the mutual inductance between the armature and field windings.

BASIC TORQUE EQUATION

The mechanical torque is equal to the load torque plus the friction and inertia [4], i.e.:

$$T = J \frac{d\omega}{dt} + B\omega + T_L \quad (5)$$

where J is the combined polar moment of inertia of the load and the rotor of the motor

$$J = J_{load} + J_{motor} \quad (6)$$

B is the damping coefficient and T_L is the load torque that opposes the electric torque. The term $B\omega$ represents the rotational loss torque of the system.

For normal operation, the mechanical torque must be equal to the electromagnetic torque developed by the motor

$$T_e = L_{af} i_f i_a \quad (7)$$

STEADY STATE OPERATION

Under steady state operation, time derivatives is zero. Assuming the motor is not saturated. The field voltage is defined as [5]

$$V_f = R_f I_f \quad (8)$$

The capital letter denotes steady state values for current and voltage. The armature voltage at steady state operation is,

$$V_a = R_a I_a + e_a = R_a I_a + L_{af} I_f \omega \quad (9)$$

Under steady state operation, the motor speed can be easily derived. If R_a is a small value (which is usual), or when the motor is lightly loaded, i.e. I_a is small (that is if the field current is kept constant), the motor speed depends only on the supply-voltage.

Rearranging equation (9) to solve for I_a , we get

$$I_a = \frac{V_a - L_{af} I_f \omega}{R_a} \quad (10)$$

Substituting equation (10) into (7), we get

$$T_e = L_{af} I_f \left(\frac{V_a - L_{af} I_f \omega}{R_a} \right) \quad (11)$$

The mutual inductance L_{af} has a constant value. If the field voltage V_f and total field resistance R_f are held to a constant value, I_f will stay constant.

With notation

$$K_v = L_{af} I_f \quad (12)$$

the equation (11) can be written as simplified form:

$$T_e = K_v \left(\frac{V_a - K_v \omega}{R_a} \right) \quad (13)$$

Based on equation (13) can be predict the electromagnetic torque T_e at a given angular speed ω if the armature voltage V_a is constant at steady state conditions. Inversely, can be predict angular speed of rotor ω at a given T_e for a constant V_a . The equilibrium equation between electromagnetic and mechanical torque is:

$$K_v I_a = B \omega + T_L \quad (14)$$

The required electrical power is:

$$P = K_v I_a \omega \quad (15)$$

CASE STUDY

For highlighting the theoretical considerations of the previous section, is considered an AMESim model of a numerical applications with the following main data: armature winding resistance

$R_a = 0.6 [\Omega]$; $R_f = 240 [\Omega]$; $L_a = 0.012 [H]$; $L_f = 120 [H]$; $J = 0.3 [kg \cdot m^2]$; $B = 0.002 [Nm/(rev/min)]$; supply voltage $U_{DC} = 240 [V]$; $K_v = 0.18 [V \cdot s/rad]$.

The simulation model of control of SEDC motor is presented in figure 3.

Speed of this type of dc shunt motor is controlled by the following methods: field control method; armature control method.

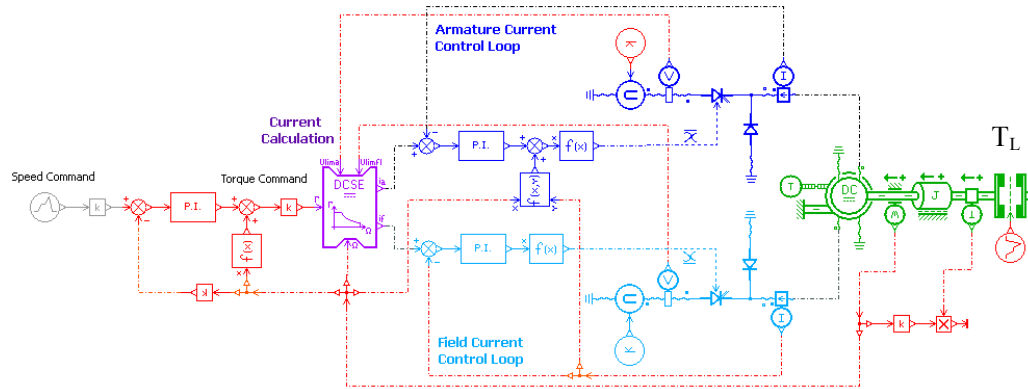

Figure 3. Simulation model of control of a SEDC motor in AMESim

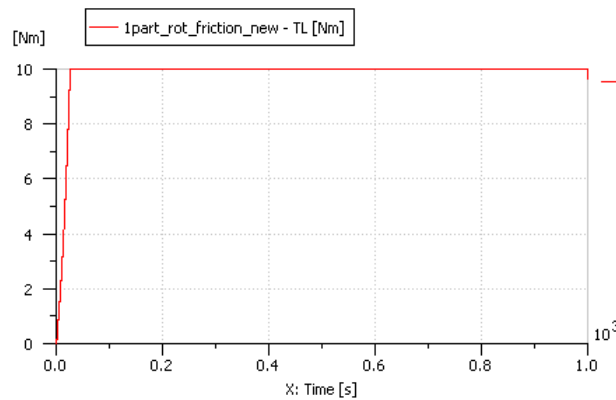

Figure 4. Mechanical torque constant

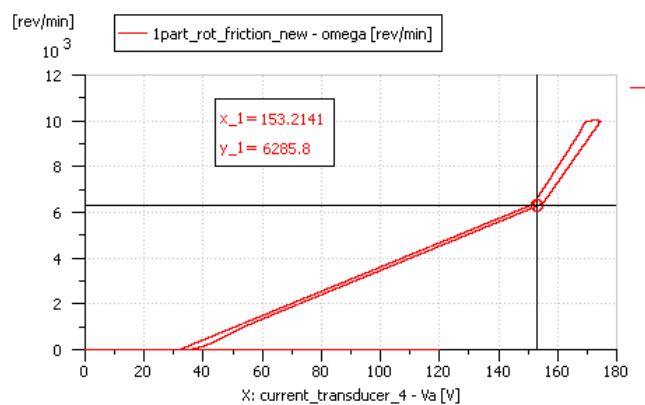

Figure 5. Speed characteristic ω as a function of armature voltage V_a

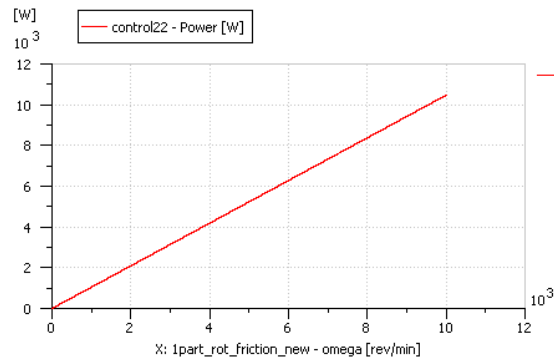

Figure 6. Electrical power P as as a function of rotor speed ω

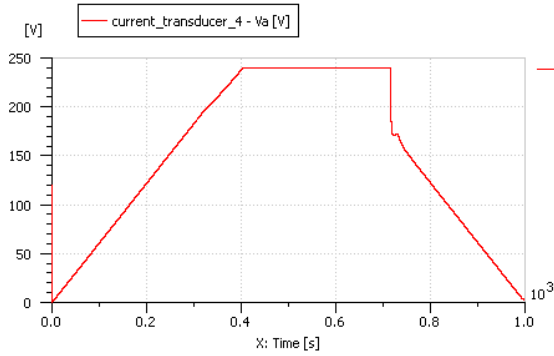

Figure 7. Time variation of armature voltaj V_a

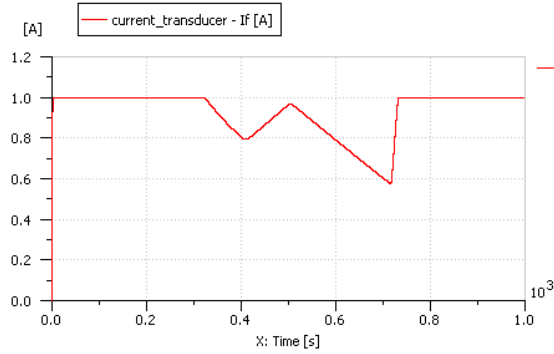

Figure 8. Field current I_f as a function of time

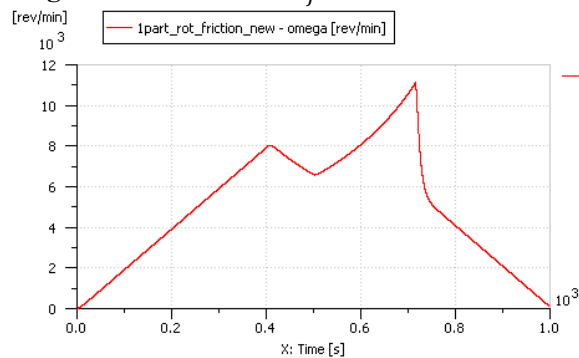

Figure 9. Speed regulation ω as a function of time

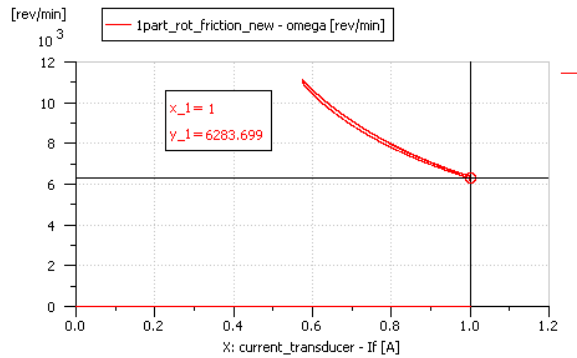

Figure 10. Speed regulation ω as a function of field current I_f

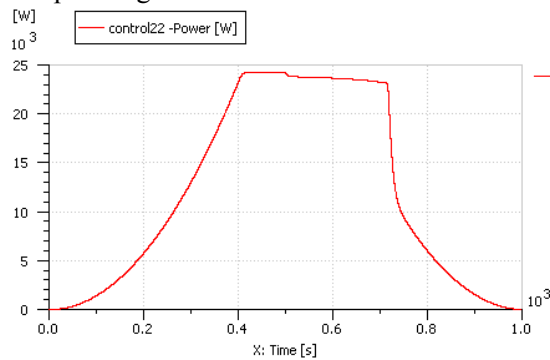

Figure 11. Electrical power as a function of time

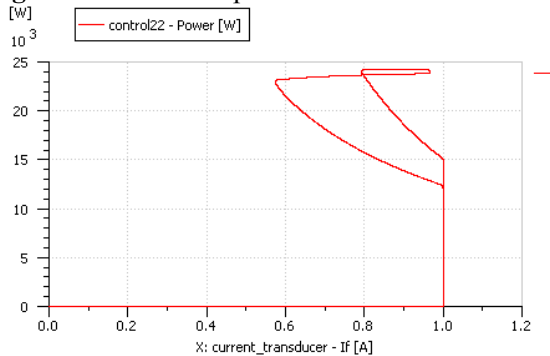

Figure 12. Electrical power P as a function of field current I_f

TORQUE AND SPEED CONTROL

From the mathematical equations, several important facts can be deduced for steady-state operation of DC motor:

- For a fixed field current, or flux i_f , the torque demand can be satisfied by varying the armature current i_a ;
- The motor speed can be varied by: controlling V_a (voltage control); controlling V_f (field control).

These observations lead to the application of variable DC voltage for controlling the speed and torque of DC motor.

SIMULATION RESULTS

The main control characteristics obtained by simulation are shown in figures 4, ...,12.

For a torque load constant $T_L = 10$ [Nm] (figure 4), speed regulation and electrical power characteristics are presented in figures 5 and 6, respectively.

For a constant armature voltage $V_a = 240$ [V] (figure 7), field current and speed regulation as functions of time are presented in figures 8 and 9, respectively. Speed regulation as a function of field current is presented in figure 10. Electrical power diagrams are presented in figures 11 and 12.

CONCLUSIONS

As can be seen in figures 5 and 10, the speed value $\omega_{base} = 6284$ [rev/min] approx., divides the simulation speed in two regions:

1. constant torque region: ($\omega \leq \omega_{base}$). In this case, i_a and i_f are maintained constant to met torque demand. V_a is varied to control the speed. Power increases with speed;
2. constant power region: ($\omega \geq \omega_{base}$). In this case, V_a is maintained at the rated value and i_f is reduced to increase speed. However, the power developed by the motor remains constant. This phenomenon is known as *field weakening*.

The speed ω_{base} is speed which correspond to the rated $V_a = 153,2141$ [V] approx., and rated $i_f=1$ [A] as shown in figures 5 and 10.

Separately excited DC motors have many industrial applications. They are often used as actuators, in trains and for automatic traction purposes.

REFERENCES

- [1] A. Hughes, *Electric motors and drives, Fundamentals, Types and Applications*, Third edition, Elsevier Ltd., Sydney, 2006.
- [2] P. C. Sen, *Principles of electrical machines and power electronics*, Second edition, John Wiley & Sons, Inc., Toronto, 1997.
- [3] P. C. Krause, O. Wasynczuk, S. D. Sudhoff, S. Pekarek, *Analysis of Electric Machinery and Drive Systems*, John Wiley & Sons Inc., IEEE Press Series on Power Engineering, 2013.
- [4] P. Wach, *Dynamics and Control of Electrical Drives*, Springer-Verlag Berlin Heidelberg, 2011.
- [5] C.B. GRAY, *Electrical machines and drive systems*, Longman Scientific and Technical, Harlow, England, 1991.